



# *net*sys

*Networking your world*

**NL-230F**

**2 Giga LAN over LRE Extender with DIP Switch**

**USER'S MANUAL**

## Table of Contents

Copyright.....	3
Foreword .....	4
Safety Warnings.....	5
<b>Chapter 1: Unpacking Information.....</b>	<b>6</b>
1.1 Check List .....	6
<b>Chapter 2: Hardware Description.....</b>	<b>7</b>
2.1 LED Indicators .....	9
2.2 Application Diagram .....	10
<b>Appendix A: Cable Requirements .....</b>	<b>11</b>
<b>Appendix B: Product Specification .....</b>	<b>13</b>
<b>Appendix C: DIN-Rail mount installation .....</b>	<b>15</b>
<b>Appendix D: Troubleshooting.....</b>	<b>16</b>
<b>Appendix E: Compliance and Safety Information .....</b>	<b>18</b>
Warranty .....	22
Chinese SJ/T 11364-2014 .....	24

## **Copyright**

Copyright © 2024 by National Enhance Technology Corp. All rights reserved.

## **Trademarks**

NETSYS is a trademark of National Enhance Technology Corp.

Other brand and product names are registered trademarks or trademarks of their respective holders.

## **Legal Disclaimer**

The information given in this document shall in no event be regarded as a guarantee of conditions or characteristics. With respect to any examples or hints given herein, any typical values stated herein and/or any information regarding the application of the device, National Enhance Technology Corp. hereby disclaims any and all warranties and liabilities of any kind, including without limitation warranties of non-infringement of intellectual property rights of any third party.

## **Statement of Conditions**

In the interest of improving internal design, operational function, and/or reliability, NETSYS reserves the right to make changes to the products described in this document without notice. NETSYS does not assume any liability that may occur due to the use or application of the product(s) or circuit layout(s) described herein.

Maximum signal rate derived from IEEE Standard specifications. Actual data throughput will vary. Network conditions and environmental factors, including volume of network traffic, building materials and construction, and network overhead, lower actual data throughput rate. Netsys does not warrant that the hardware will work properly in all environments and applications, and makes no warranty and representation, either implied or expressed, with respect to the quality, performance, merchantability, or fitness for a particular purpose. Make sure you follow in line with the environmental conditions to use this product.

## **NL-230F - 2Giga LAN over LRE Extender with DIP Switch USER'S MANUAL Ver.A.5**

### **Foreword**

The Netsys' NL-230F is a 2 Giga LAN over LRE Extender with DIP switch that's built in Long Reach Ethernet (LRE) UTP / Coaxial /Fiber Optic for data transmission via 10/100/1000BASE-T Ethernet cable (UTP) over LRE UTP/ Coaxial &1.25G/2.5G SFP Fiber modules. With DIP switch on rear side of NL-230F, it's easy for customer to configure SFP Mode for 100M/1.25G/2.5G and LRE of single pair mode as well as 10/100/1000 Base-T Ethernet ports support selection by DIP switch, etc. NL-230F support auto-negotiation & auto-MDIX to properly set up the most stable & fastest connection between NL-230F and support multimedia interface converter such as copper wire / coaxial cable / fiber optic.

NL-230F support 2 x 10/100/1000 Base-T LAN over LRE 10 / 100Mbps Copper / Coaxial and 1.25G/2.5G fiber optic network, and small form-factor pluggable transceiver is required. NL-230F also supports 9K bytes jumbo frames pass-through which is perfect to utilize in AI, IoT, video streaming application, VOIP, etc.

With high performance of data transmission and easy installation, NL-230F is suitable for ISP to build their FTTB/FTTC/FTTBdp network and point to point application in more cost-effective way.

#### **Attention:**

**Be sure to read this manual carefully before using this product. Especially Legal Disclaimer, Statement of Conditions and Safety Warnings.**

#### **Caution:**

The NL-230F is for **indoor** applications only. This product does not support waterproof protection. Do not use in harsh environments (Over temperature range: 0°C ~ 50°C (32°F ~ 122°F)).

## **Safety Warnings**

For your safety, be sure to read and follow all warning notices and instructions before using the device.






- ◆ **DO NOT** open the device or unit. Opening or removing covers can expose you to dangerous high voltage points or other risks. ONLY qualified service personnel can service the device. Please contact your vendor for further information.
- ◆ **Use ONLY** the dedicated power supply for your device. Connect the power cord or power adapter to the right supply voltage (110V AC used for North America and 230V AC used for Europe).
- ◆ **DO NOT** use the device if the power supply is damaged as it might cause electrocution. If the power supply is damaged, remove it from the power outlet. DO NOT attempt to repair the power supply. Contact your local vendor to order a new power supply.
- ◆ **Place** connecting cables carefully so that no one will step on them or stumble over them. DO NOT allow anything to rest on the power cord and do not locate the product where anyone can work on the power cord.
- ◆ **DO NOT** install nor use your device during a thunderstorm. There may be a remote risk of electric shock from lightning.
- ◆ **DO NOT** expose your device to dampness, dust or corrosive liquids.
- ◆ **DO NOT** use this product near water, for example, in a wet basement or near a swimming pool.
- ◆ **Connect ONLY** suitable accessories to the device. Make sure to connect the cables to the correct ports.
- ◆ **DO NOT** obstruct the device ventilation slots, as insufficient airflow may harm your device.
- ◆ **DO NOT** place items on the device.
- ◆ **DO NOT** use the device for outdoor applications, and make sure all the connections are indoors. There may be a remote risk of electric shock from lightning.
- ◆ **Be careful** when unplugging the power, because the transformer may be very hot.
- ◆ **Keep** the device and all its parts and accessories out of children's reach.
- ◆ **Clean** the device using a soft and dry cloth rather than liquid or atomizers. Power off the equipment before cleansing it.
- ◆ This product is **recyclable**. Dispose of it properly.

# Chapter 1. Unpacking Information

## 1.1 Check List

Carefully unpack the package and check its contents against the check list.

### Package Contents:

				
1 x NL-230F	1 x QR code for user's manual hyperlink.	Accessory: 4 x Rubber Feet , 1 x Ethernet Cable, 1 x DC12V Adapter 1 x SFP cover		

### Notes:

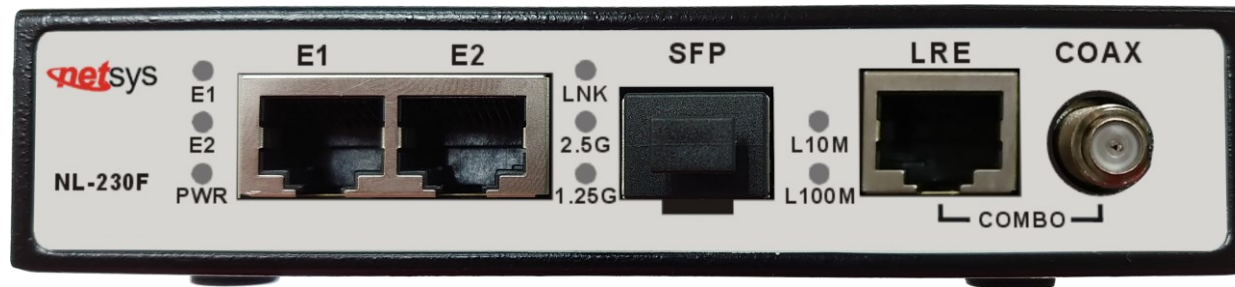
1. Please inform your dealer immediately for any missing or damaged parts. If possible, retain the carton including the original packing materials. Use them to repack the unit in case there is a need to return for repair.
2. If the product has any issue, please contact your local vendor.
3. Do not use sub-standard power supply. Before connecting the power supply to the device, be sure to check compliance with the specifications. The NL-230F uses a DC 12V/1A power supply.
4. The power supply included in the package is commercial-grade. Do not use in industrial-grade applications.
5. Please look for the QR code on the bottom of the product, the user can launch the QR code scanning program to scan and download the user's manual electronic format file. Above QR code icon is for reference.

## **Chapter 2. Hardware Description**

This section describes the important parts of the converter. It features the front panel and rear panel.

1. Front Panel: The front panel provides F-Connector / SFP Slot, Ethernet Connector and LED indicators of the converter.

Front panel indicator: There are 8 LED indicators on Converter, the following Table shows the description.



**Figure 2.1 Front Panel**

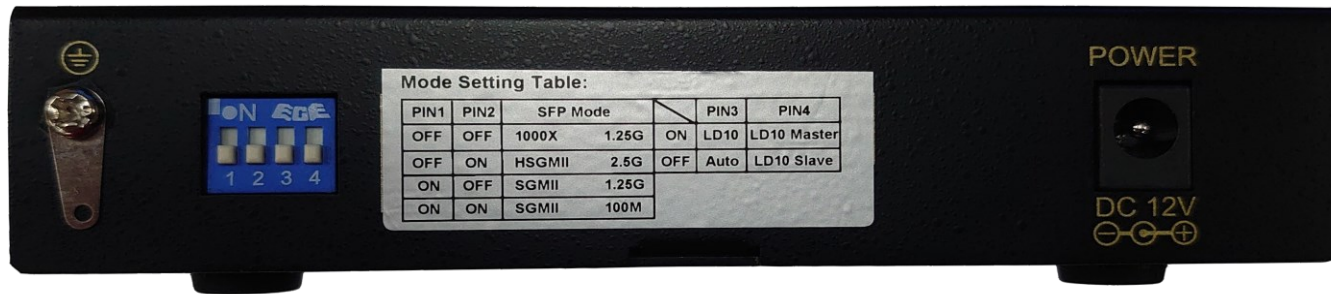
Tip: With only a glance of the front panel, the converter status will be fully aware.

**Table 2-1 Description of the front interface**

Connectors	Type	Description
LAN1 & LAN2	RJ-45	For connecting to a Networking device.
SFP	SFP slot	For small form-factor pluggable SFP transceiver.
LRE / COAX	RJ-45 / F-connector	Combo port for connecting to an opposite NL-230F's LRE port

2. Rear Panel: The rear panel provides Power DC Jack, mode-switching table and Dip Switch.

**NL-230F - 2Giga LAN over LRE Extender with DIP Switch USER'S MANUAL Ver.A.5**



**Figure 2.2 Rear Panel**

**SFP Slot Mode Selection Table:**

PIN 1	PIN 2	SFP Mode
OFF	OFF	1000X 1.25G
OFF	ON	HSGMII 2.5G
ON	OFF	SGMII 1.25G
ON	ON	SGMII 100M

**LD Mode Table:**

	PIN 3	PIN 4
ON	LD10 Mode (force single twist pair copper wire)	LD10 Master
OFF	Auto mode (two twist pair copper wire)	LD10 Slave

Note: 1) LD10 mode support single twisted pair copper wire (Rj45 pin 1 & pin2) and fix 10Mbps speed, if enable LD10 Mode (pin3 turn on), and also need to set LD10 master and opposite site must be set LD10 Slave (pin 4).  
 2) Auto mode must be installed over two twisted pairs copper wire for auto-negotiation LD100 mode and LD10 mode



## **NL-230F - 2Giga LAN over LRE Extender with DIP Switch USER'S MANUAL Ver.A.5**

### **2.1 LED Indicators**

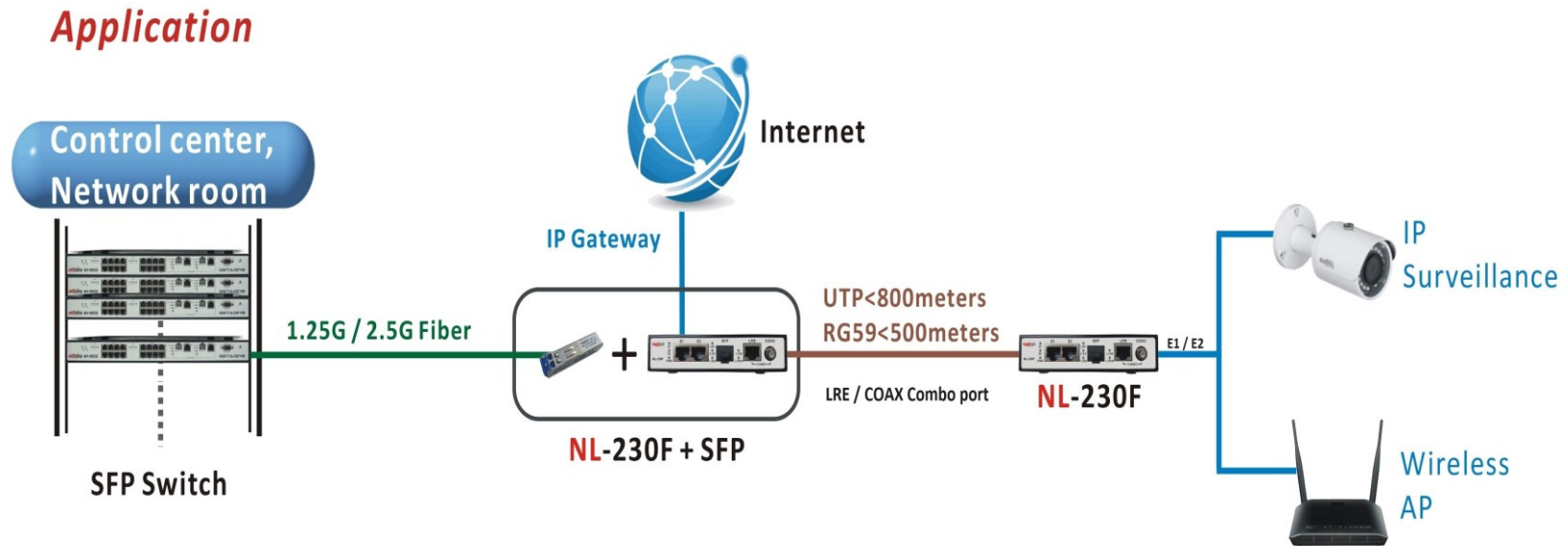
The NL-230F Converter has 10 LED indicators. The following Table shows the description. ([Table 2-1](#))

**Table 2-1 LED Indicators Description and Operation**

LEDs	Color	Status	Description
<b>PWR</b>	Green	ON	Power Good
		OFF	Power Failure
<b>LAN1 &amp; LAN2 LNK/ACT</b>	Green	ON (Steady)	Link Status
		Blinking Fastly	Active Status
		Blinking Slowly	Data transmission Status
		OFF	No connection
<b>LNK SFP</b>	Green	ON	Link Status
		OFF	No connection
<b>SFP 1.25G</b>	Green	ON	Config on 1.25G SFP mode
<b>SFP 2.5G</b>	Green	ON	Config on 2.5G SFP mode
<b>L10M</b>	Green	ON / Blinking	Link / Active on LRE 10M mode
<b>L100M</b>	Green	ON / Blinking	Link / Active on LRE 100M mode

**2.2 Application Diagram**

Even though Fiber optic is a proper developed technology, it still can't reach some places due to cost & physical limit. NL-230F is a 2 Giga LAN over LRE extender that supports data transmission between Fiber optic and Coax. on the end point, which give you an alternative way to extend the bandwidth to Maximum 2.5Gbps without further wiring renovation.



**Figure 2.2 Application Diagram**

## **Appendix A: Cable Requirements**

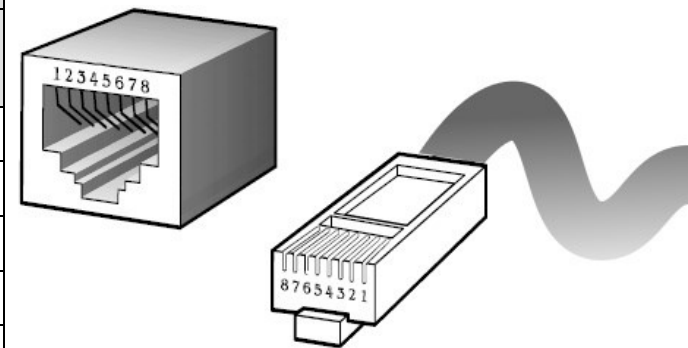
### **Ethernet Cable**

A CAT 5~7 UTP (unshielded twisted pair) cable is typically used to connect the Ethernet device to the Modem. A: 10/100TX cable often consists of four pairs of wires, two of which are used for transmission. The connector at the end of the 10/100TX cable is referred to as a RJ-45 connector and it consists of eight pins. The Ethernet standard uses pins 1, 2, 3 and 6 for data transmission purposes. (Table A-1 10/100TX)

B: 1000TX cable often consists of four pairs of wires, all of which are used for transmission. The connector at the end of the 1000TX cable is referred to as a RJ-45 connector and it consists of eight pins. The Ethernet standard uses pins 1, 2, 3, 4, 5 and 6 for data transmission purposes. (Table A-1 1000TX)

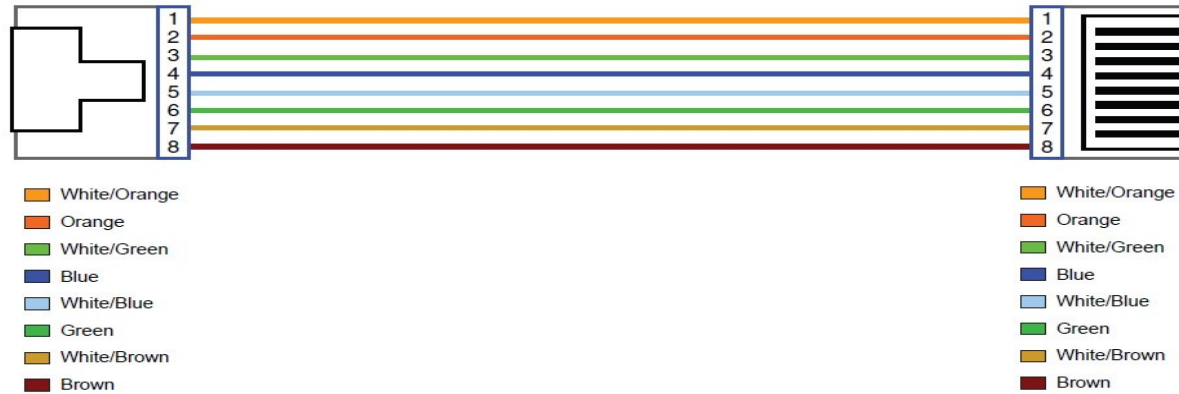
**Table A-1** RJ-45 Ethernet Connector Pin Assignments

PIN #	10/100TX		1000TX	
	Signal	Media Dependant interface	Signal	Media Dependant interface-cross
1	TX+	Transmit Data+	BI_DA+	Bi-directional pair A+
2	TX-	Transmit Data-	BI_DA-	Bi-directional pair A-
3	RX+	Receive Data+	BI_DB+	Bi-directional pair B+
4	NC	Unused	BI_DC+	Bi-directional pair C+
5	NC	Unused-	BI_DC-	Bi-directional pair C-
6	RX-	Receive Data-	BI_DB-	Bi-directional pair B-
7	NC	Unused	BI_DD+	Bi-directional pair D+
8	NC	Unused	BI_DD-	Bi-directional pair D-

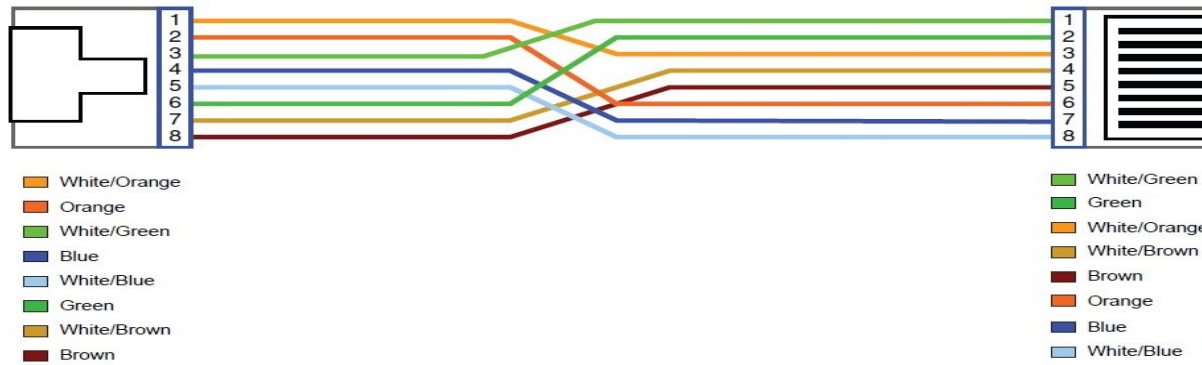


**Figure A-1 Standard RJ-45 repectacle/connector**

**NL-230F - 2Giga LAN over LRE Extender with DIP Switch USER'S MANUAL Ver.A.5**



**Figure A-2 Pin Assignments and Wiring for an RJ-45 Straight-Through Cable**



**Figure A-3 Pin Assignments and Wiring for an RJ-45 Crossover Cable**

**Note : LD10 single pair mode, its pin arrangement by RJ45 pin1 and pin2**

**Coaxial Cable : RG59/U 75Ω**

## **Appendix B: Product Specification**

### **Key Features and Benefits:**

- ◆ Support Multimedia interface converter such as copper wire / coaxial cable /fiber optic
- ◆ Supports 2 x 10/100/1000Base-T & auto –MDIX for RJ-45 port
- ◆ Support 1 x RJ45 / F-connector LRE Combo port
- ◆ Support single pair copper wire (Rj45 pin1 & pin2) by DIP switch setting
- ◆ Supports 1 x 1.25G / 2.5G SFP slot
- ◆ LRE UTP port support 10Mbps up to 800 meters / 100Mbps up to 500 meters / Coax port up to 500 meters (depend on RG59/U cable quality)
- ◆ Supports up to 9K jumbo frames
- ◆ Supports DIP switch for selecting 1000X/SerDes 1.25G, HSGMII 2.5G, SGMII 1.25G, SGMII 100M SFP slot mode & RJ-45 isolation / non-isolation mode
- ◆ Supports LFP (Link Fault Passthrough) function
- ◆ Built in surge protector for LRE port
- ◆ Supports DIN-Rail (Optional) / Wall Mounting / Bracket installation
- ◆ Metal case design with compact in size, easy installation
- ◆ Plug & Play
- ◆ Flexible application & installation

## NL-230F - 2Giga LAN over LRE Extender with DIP Switch USER'S MANUAL Ver.A.5

### Specifications:

Item	Description
<b>Protocol and Standards</b>	IEEE 802.3u / IEEE802.3ab / IEEE802.3z
<b>Cabling requirements</b>	Ethernet: 10/100/1000Base-T Cat.5 or above UTP Cable Coaxial: RG59/U Fiber Optic: Flexible (Depending on Fiber Transceiver)
<b>SFP Modes</b>	1000X/SerDes, HSGMII 2.5G, SGMII 1.25G, SGMII 100M
<b>Interface</b>	2 x RJ-45 10/100/1000Mbps auto-negotiation Ethernet port · 1 x SFP slot · 1 x F-connector · 1 x DIP switch · 1 x DC power jack
<b>Jumbo Frame</b>	9K bytes
<b>LED Indication</b>	PWR LAN1/LAN2: Link/ACT, 1Gbps, 100Mbps SFP slot: Link, 2.5G, 1.25G L10M / L100M : LRE 10M /100M / Link/Active
<b>Certification</b>	CE, FCC, RoHS Compliant
<b>Temperature</b>	0°C ~ 50°C (32°F ~ 122°F) (Operating ) -20°C ~ 70°C (-4°F ~ 158°F) (Storage )
<b>Optional accessories</b>	Din Rail Type-B mounting plate
<b>Humidity</b>	10 - 90% (non-condensing)
<b>Weight</b>	352g
<b>Dimensions</b>	124mm x 93mm x 27mm (4.88" x 3.66"x 1.06")
<b>Power Consumption</b>	1.6W Typical
<b>Power Adapter</b>	Input : AC 100~240 volts/50~60Hz Output : DC 12V/1A

## **Appendix C: DIN-Rail mount installation**

This appendix describes how to install DIN-Rail Type-B(optional) to the bridged. The accessory is optional.

◆ Please refer to install the DIN-RAIL as following step:

1. Install the DIN-Rail mounting plate to the **NL-230F**. (Figure C-1)
2. Please use the suitable DIN-Rail to install, please refer to the dimensions of DIN-Rail (Figure C-2)
3. Insert the top of the DIN-Rail into the top slots on the DIN-Rail mounting plate and the DIN-Rail mounting plate will snap into place. (Figure C-3)



Figure C-1

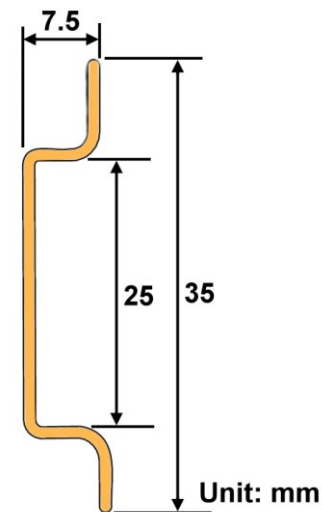


Figure C-2

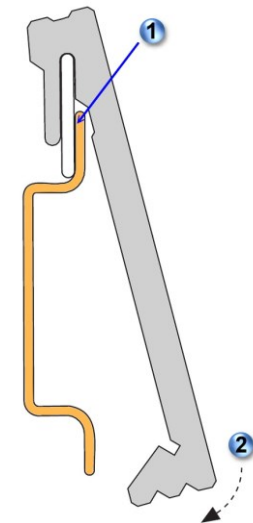


Figure C-3

## **Appendix D: Troubleshooting**

### **Diagnosing Giga Media Converter Indicators**

NL230F can be easily monitored through its comprehensive panel indicators. These indicators assist in identifying problems you may encounter. This section describes common problems you may encounter and possible solutions:

<b>1. Symptom:</b>	POWER indicator does not light up (green) after power on.
<b>Cause:</b>	Defective External power supply
<b>Solution:</b>	Check the power plug by plugging in another that is functioning properly. Check the power cord with another device. If these measures fail to resolve the problem, have the unit power supply replaced by a qualified distributor.
<b>2. Symptom:</b>	Link indicator does not light up (green) after making a connection.
<b>Cause:</b>	Network interface (ex. a network adapter card on the attached device), network cable, or switch port is defective.
<b>Solution:</b>	<ul style="list-style-type: none"><li>◆ Verify if both of the Ethernet over LRE Extender (all devices) and attached device are powered on.</li><li>◆ Be sure the Ethernet cable and fiber optics are plugged into both the switch and corresponding device.</li><li>◆ Verify that the proper cable type is used and its length does not exceed specified limits.</li><li>◆ Check the Adapter on the attached device and cable connections for possible defects.</li><li>◆ The LRE's RJ-45 and Coaxial port cannot be used simultaneously.</li><li>◆ Verify SFP Mode setting is correctly and repower after DIP switch setting</li></ul>



## **System Diagnostics**

### **Power and Cooling Problems**

If the POWER indicator does not turn on when the power cord is plugged in, you may have a problem with the power outlet, power cord, or internal power supply. However, if the unit power is off after running for a while, check for loose power connections, power losses or surges at the power outlet. If you still cannot isolate the problem, then the internal power supply may be defective. In this case, please contact your local dealer.

### **Installation**

Verify that all system components have been properly installed. If one or more components appear to be malfunctioning (e.g. the power cord or network cabling), test them in an alternate environment where you are sure that all the other components are functioning properly.

### **Transmission Mode**

The default of transmission mode for RJ-45 ports is 10/100/1000 Mbps LAN port, for SFP port is 1.25Gbps/2.5Gbps SFP mode, for LRE UTP port is 10Mbps / 100Mbps or Coax port is 100Mbps, Therefore, if the Link signal is disrupted (e.g. by unplugging the network cable and plugging it back in again, or by resetting the power), the port will try to re-establish connection with the attached device via auto-negotiation

### **Physical Configuration**

If problems occur after altering the network configuration, restore the original connections, and try to track the problem down by implementing the new changes, one step at a time. Ensure that cable distances and other physical aspects of the installation do not exceed recommendations.

### **System Integrity**

As a last resort verify the switch integrity with a power-on reset. Turn the power to the switch off and then on several times. If the problem still persists and you have completed all the preceding diagnoses, then contact your dealer.

## **Appendix E: Compliance and Safety Information**

### **FCC Radio Frequency Interference Statement**

This equipment has been tested and found to comply with the limits for a computing device, pursuant to Part 15 of FCC class B rules. These limits are designed to provide reasonable protection against harmful interference when the equipment is operated in a commercial environment. This equipment generate, uses and can radiate radio frequency energy and, if not installed and used in accordance with the instructions, may cause harmful interference to radio communications. However, there is no guarantee that interference will not occur in a particular installation. If this equipment does cause harmful interference to radio or television reception, which can be determined by turning the equipment off and on, the user is encouraged to try to correct the interference by one or more of the following measures:

1. Reorient or relocate the receiving antenna.
2. Increase the separation between the equipment and receiver.
3. The equipment and the receiver should be connected to outlets on separate circuits.
4. Consult the dealer or an experienced radio/television technician for help.

Changes or modifications not expressly approved by the party responsible for compliance could void the user's authority to operate the equipment.

If this telephone equipment causes harm to the telephone network, the telephone company will notify you in advance that temporary discontinuance of service may be required. But if advance notice isn't practical, the telephone company will notify the customer as soon as possible. Also, you will be advised of your right to file a complaint with the FCC if you believe it is necessary.

The telephone company may make changes in its facilities, equipment, operations or procedures that could affect the

## **NL-230F - 2Giga LAN over LRE Extender with DIP Switch USER'S MANUAL Ver.A.5**

proper functioning of your equipment. If they do, you will be notified in advance in order for you to make necessary modifications to maintain uninterrupted service.

This equipment may not be used on coin service provided by the telephone company. Connection to party lines is subject to state tariffs.

### **Important Safety Instructions**

- ◆ **Caution:** The direct plug-in wall transformer serves as the main product for disconnecting. The socket outlet shall be installed near the product and be readily accessible.
- ◆ **Caution:** Use only the power supply included with this product. In the event the power supply is lost or damaged: In the United States, use only with CSA certified or UL listed Class 2 power supply, rated **12VDC 1A** or above.  
IN Europe, use only with CE certified power supply, rated **12VDC 1A** or above.
- ◆ **Do not** use this equipment near water, for example in a wet basement.
- ◆ **Avoid** using a telephone during an electrical storm. There may be a remote risk of electrical shock from lightning.
- ◆ **Do not** use the telephone to report a gas leak in the vicinity of the leaking area.
- ◆ If you experience trouble with this unit, please contact customer service of your dealer immediately.
- ◆ **DO NOT DISASSEMBLE THIS EQUIPMENT.** It does not contain any user serviceable components.

## **FCC Warning**



This equipment has been tested to comply with the limits for a Class A digital device, pursuant to FCC 47 CFR Part 15 subpart B : 2018 of the FCC Rules. These limits are designed to provide reasonable protection against harmful interference when the equipment is operated in a commercial environment.

This equipment can generate, use, and radiate radio frequency energy and, if not installed and used in accordance with the instruction manual, may cause harmful interference to radio communications. Operation of this equipment in a residential area is likely to cause harmful interference in which case the user will be required to correct the interference at owner's expense.

## **CE Mark Warning**



This is a Class A product. In a domestic environment, this product may cause radio interference in which case the user may be required to take adequate measures.

## RoHS Mark Warning



RoHS stands for Restriction of Hazardous Substances, and impacts the entire electronics industry and many electrical products as well. The original RoHS, also known as Directive 2002/95/EC, originated in the European Union in 2002 and restricts the use of six hazardous materials found in electrical and electronic products. All applicable products in the EU market since July 1, 2006 must pass RoHS compliance. Directive 2011/65/EU was published in 2011 by the EU, which is known as RoHS-Recast or RoHS 2. RoHS 2 includes a **CE-marking directive**, with RoHS compliance now being required for CE marking of products. RoHS 2 also added Categories 8 and 9, and has additional compliance recordkeeping requirements. Directive 2015/863 was published in 2015 by the EU, which is known as RoHS 3. RoHS 3 adds four additional restricted substances (phthalates) to the list of six.

## WEEE Warning



To avoid the potential effects on the environment and human health as a result of the presence of hazardous substances in electrical and electronic equipment, end users of electrical and electronic equipment should understand the meaning of the crossed-out wheeled bin symbol. Do not dispose of WEEE as unsorted municipal waste and have to collect such WEEE separately.

## **Warranty**

The original owner that the product delivered in this package will be free from defects in material and workmanship for two years parts after purchase.

There will be a minimal charge to replace consumable components, such as fuses, power transformers, and mechanical cooling devices. The warranty will not apply to any products which have been subjected to any misuse, neglect or accidental damage, or which contain defects which are in any way attributable to improper installation or to alteration or repairs made or performed by any person not under control of the original owner.

The above warranty is in lieu of any other warranty, whether express, implied, or statutory, including but not limited to any warranty of merchantability, fitness for a particular purpose, or any warranty arising out of any proposal, specification, or sample. We shall not be liable for incidental or consequential damages. We neither assume nor authorize any person to assume for it any other liability.

## **EXCLUSION OF WARRANTY**

1. Improper use
2. Operation beyond capabilities
3. Failure to report defect in warranty period
4. Substitution of parts
5. Damage due to misapplication
6. Lack of proper maintenance
7. Abuse
8. Improper installation
9. Abnormal operating conditions – temperature, humidity, corrosive elements
10. Repair by others
11. Improper packaging and shipping.
12. Natural disaster
13. Warranty sticker be removed or seal broken

**WARNING**  
**Warranty Void**  
**If Removed**

**NL-230F - 2Giga LAN over LRE Extender with DIP Switch USER'S MANUAL Ver.A.5**

**Chinese SJ/T 11364-2014**

部件名称	有毒有害物质或元素					
	铅(Pb)	汞(Hg)	镉(Cd)	六价铬[Cr(VI)]	多溴联苯(PBB)	多溴二苯醚(PBDE)
结构壳体	○	○	○	○	○	○
电路组	○	○	○	○	○	○
电源供应器	○	○	○	○	○	○
线材	○	○	○	○	○	○
包装及配件	○	○	○	○	○	○

○：表示该有毒物质在该部件所有均质材料中的含量均在 GB/T 26572 标准规定的限量要求以下。  
×：表示该有毒物质至少在该部件的某依均质材料中的含量超出 GB/T 26572 标准规定的限量要求。

上述规范仅适用于中国法律